

# PROJEKT TRŽNICE

---



**REKONSTRUKCIJA PARTERA  
OTVORENOG  
DIJELA TRŽNICE**

**NATKRIVANJE  
OTVORENOG DIJELA  
TRŽNICE**

**STVARANJE NOVOG  
VIZUALNOG IDENTITETA**



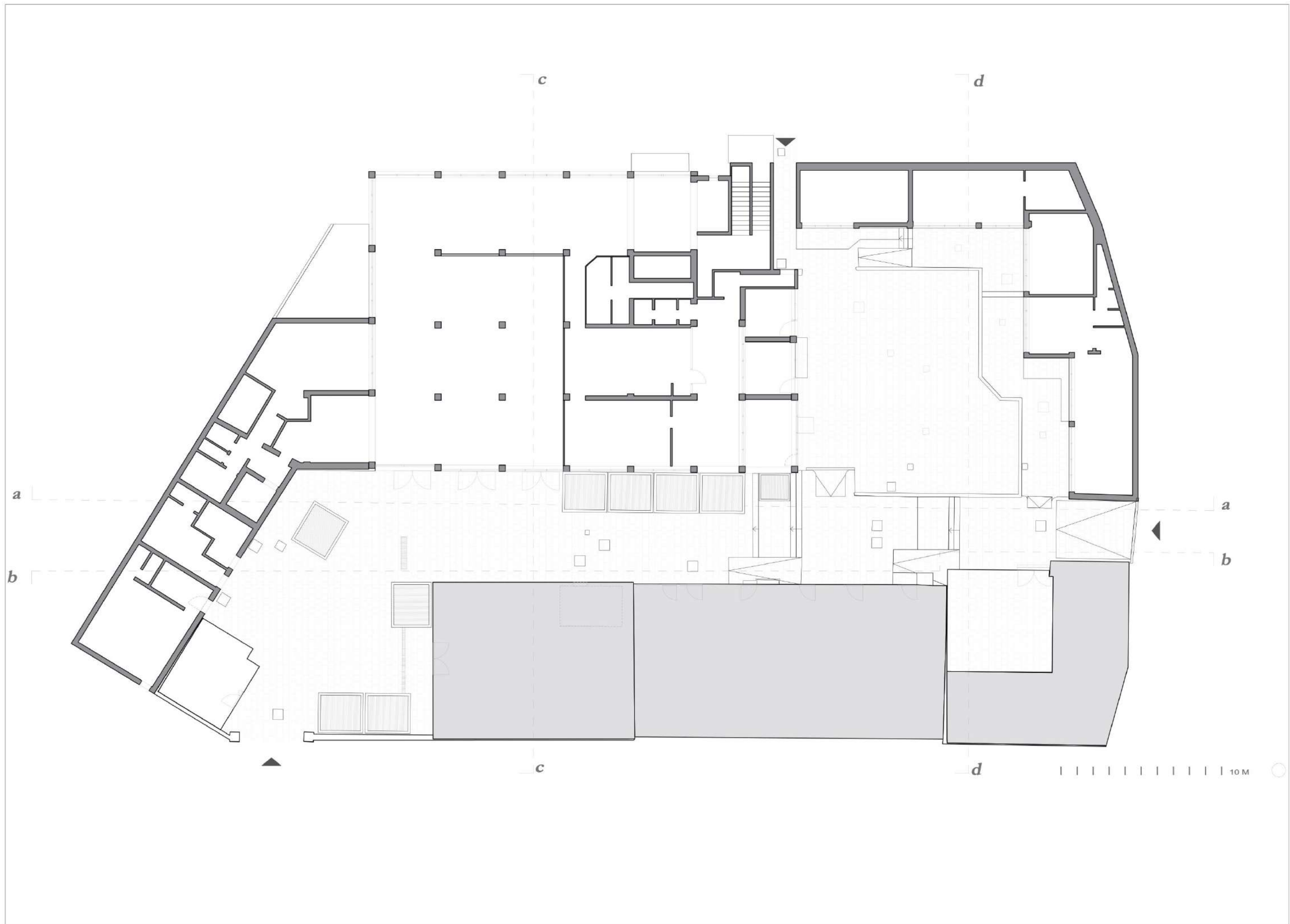

tlocrt - prizemlje

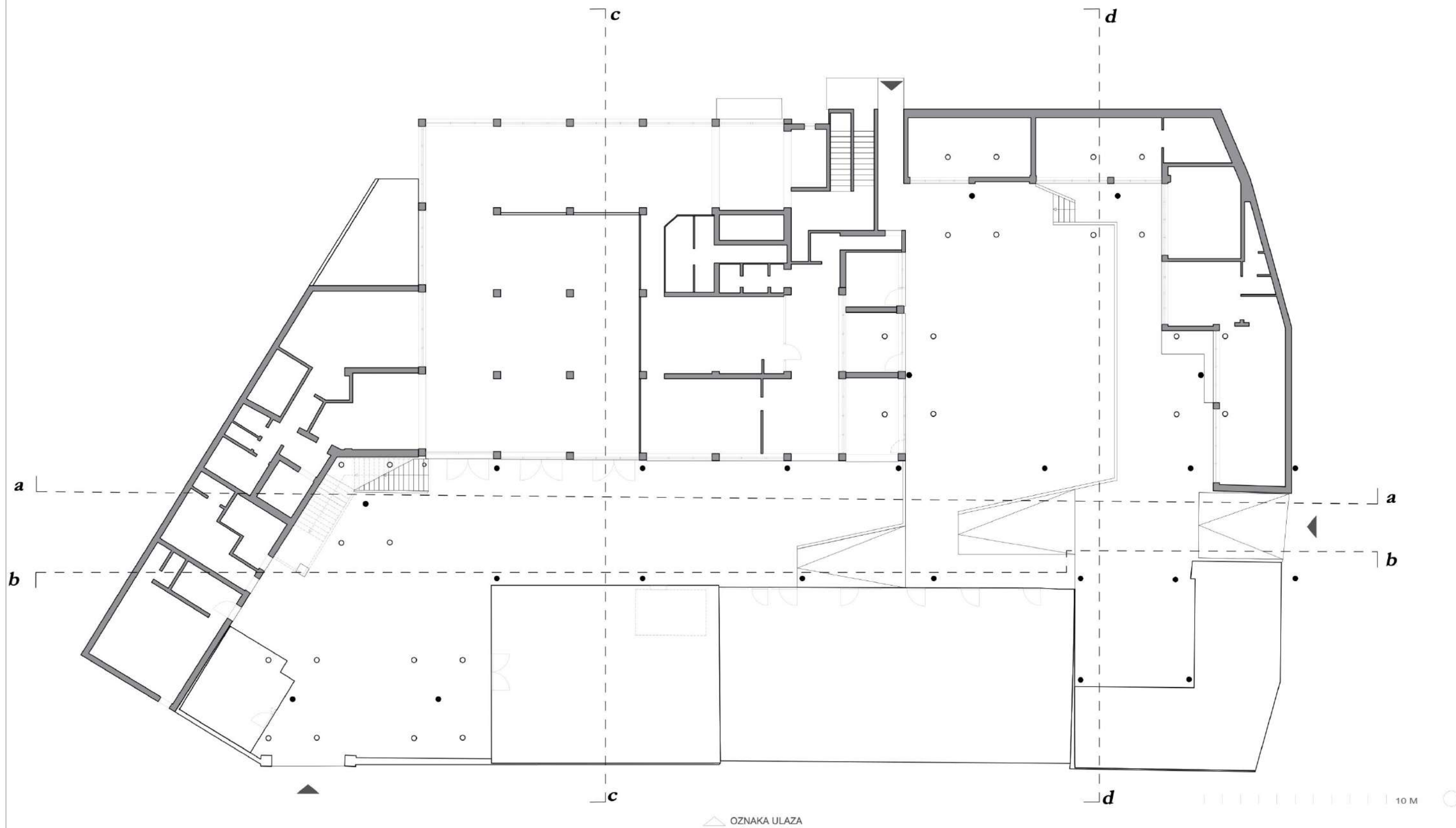

OZNAKA ULAZA

10 M

tlocrt - kote

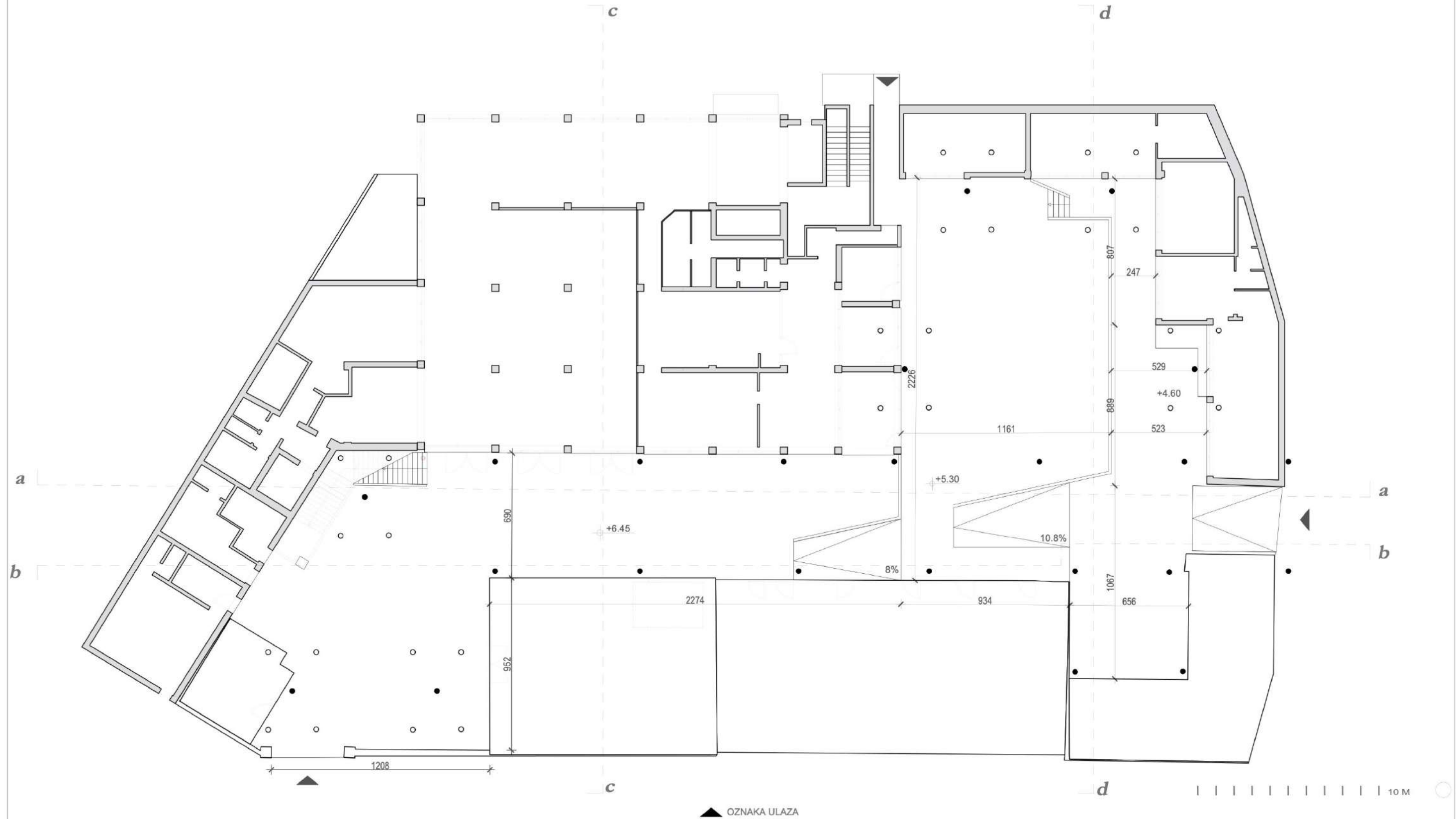



TLOCRT PARTERA TRŽNICE - OPLOČENJE

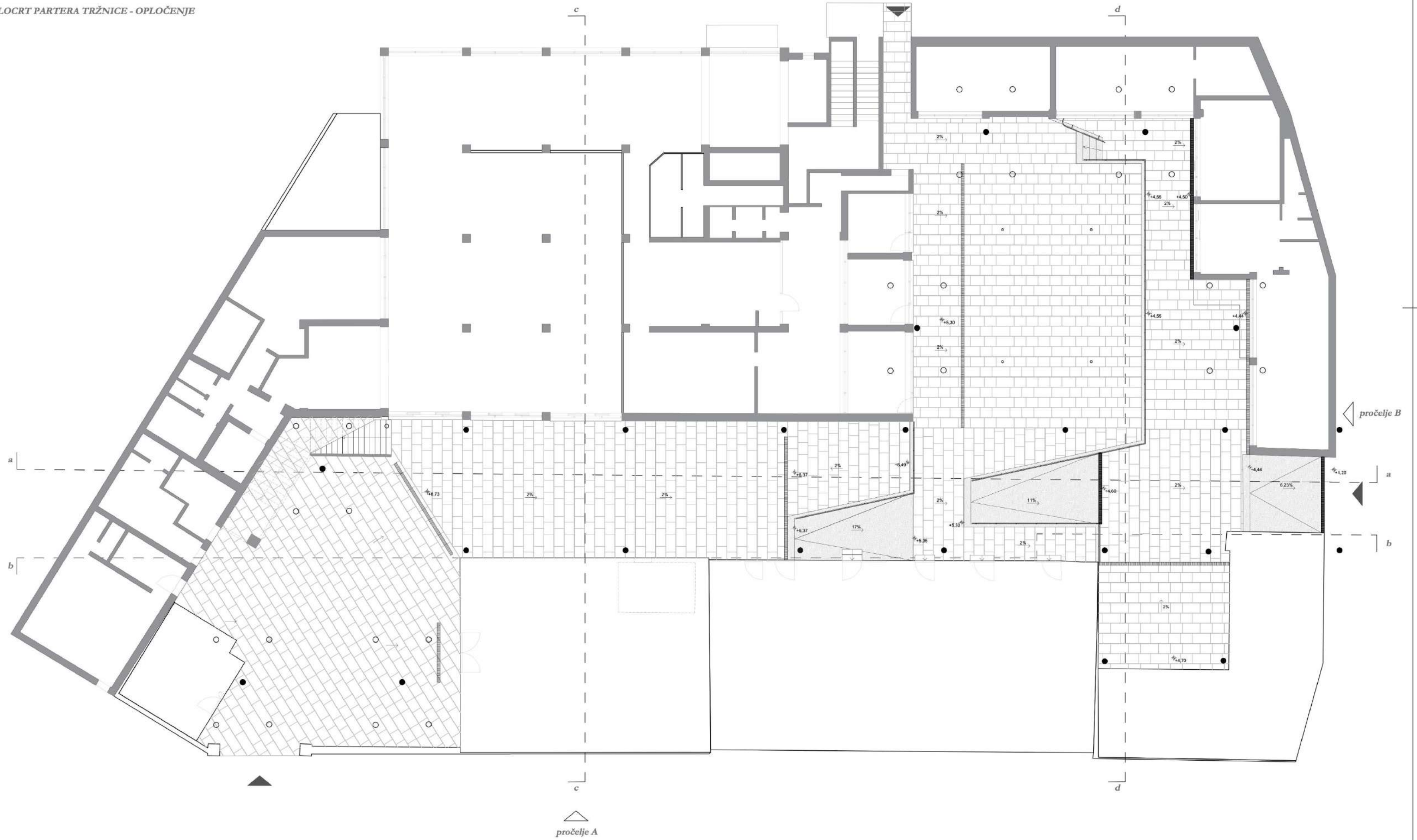

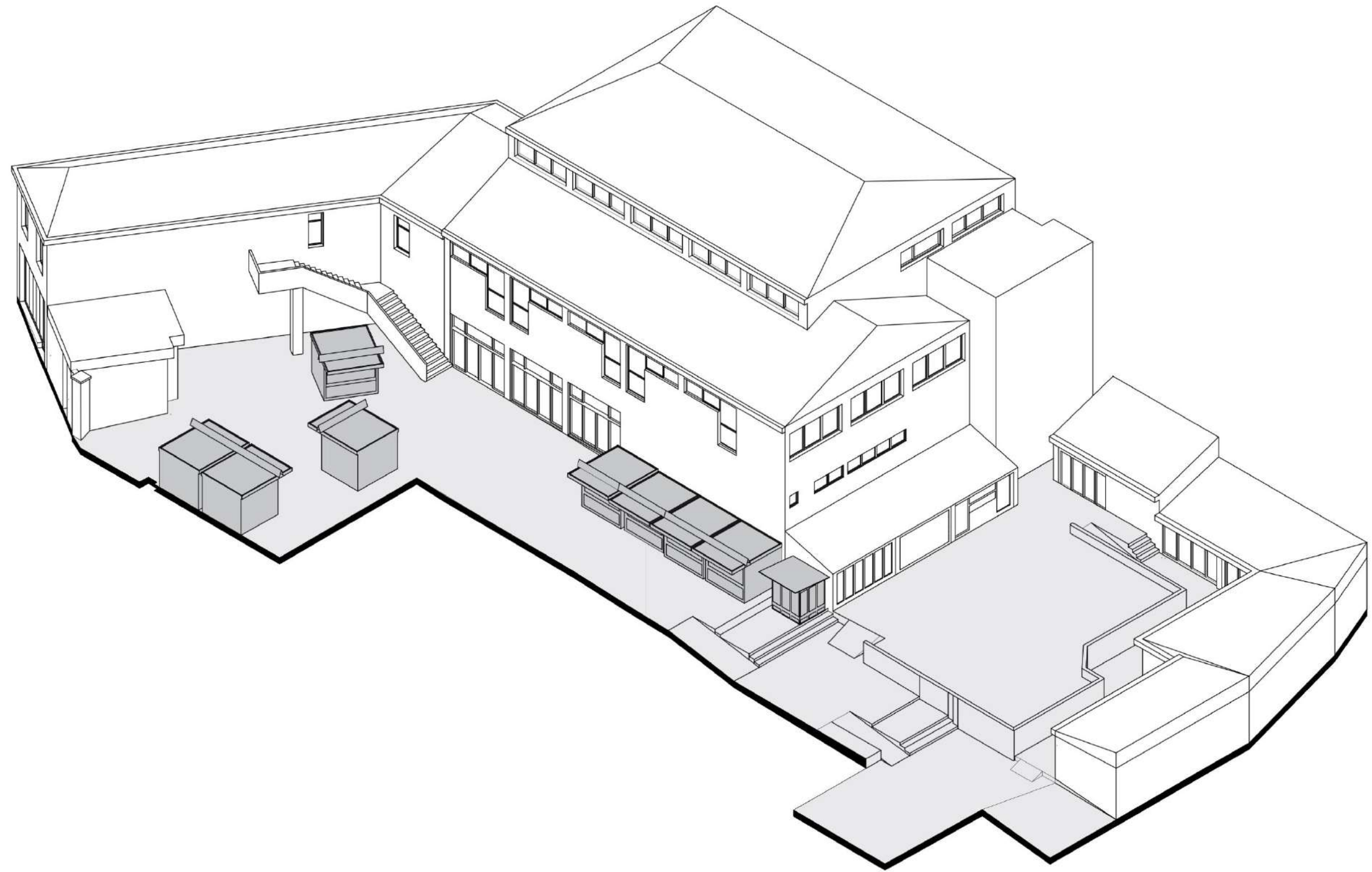

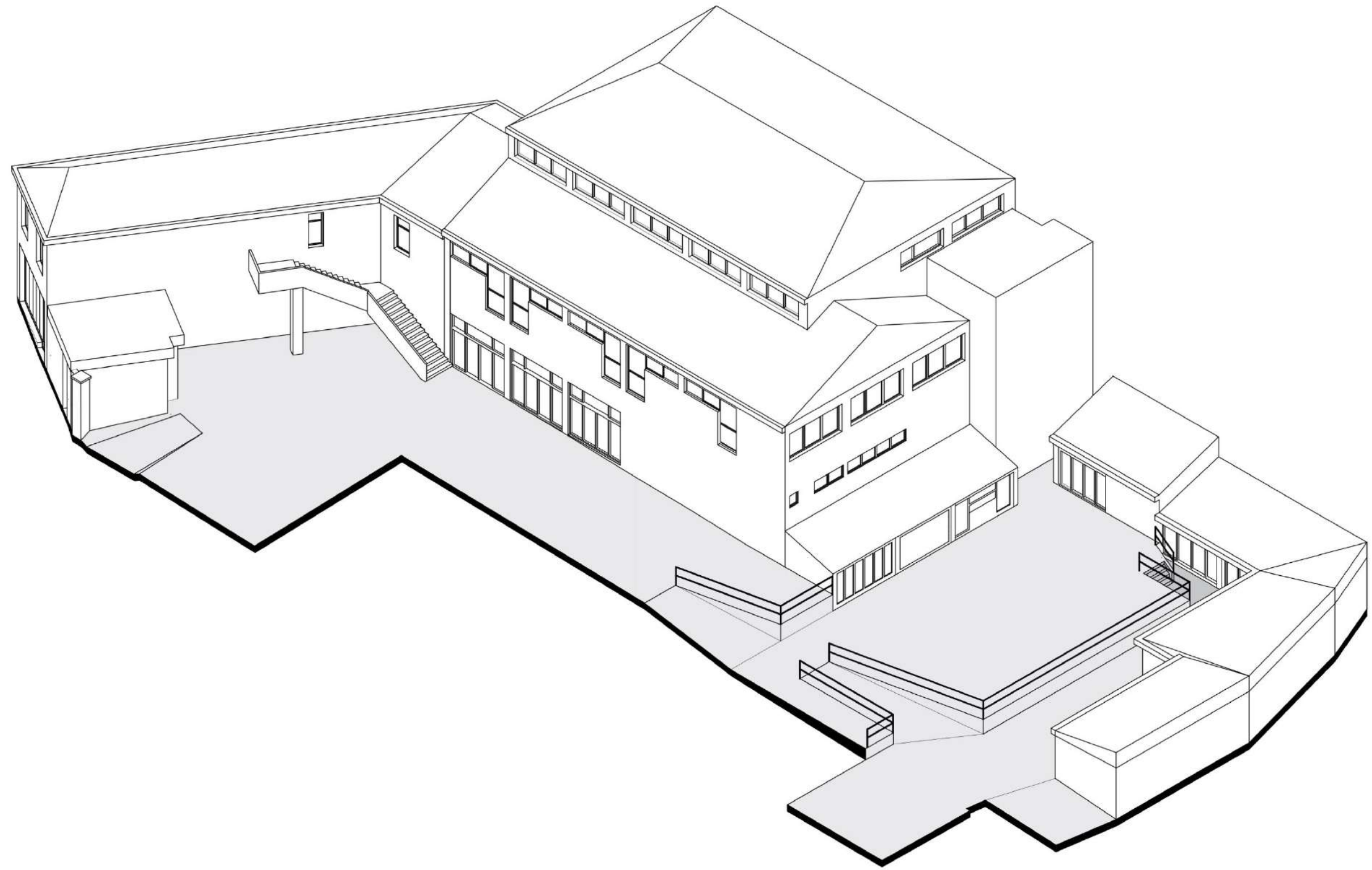

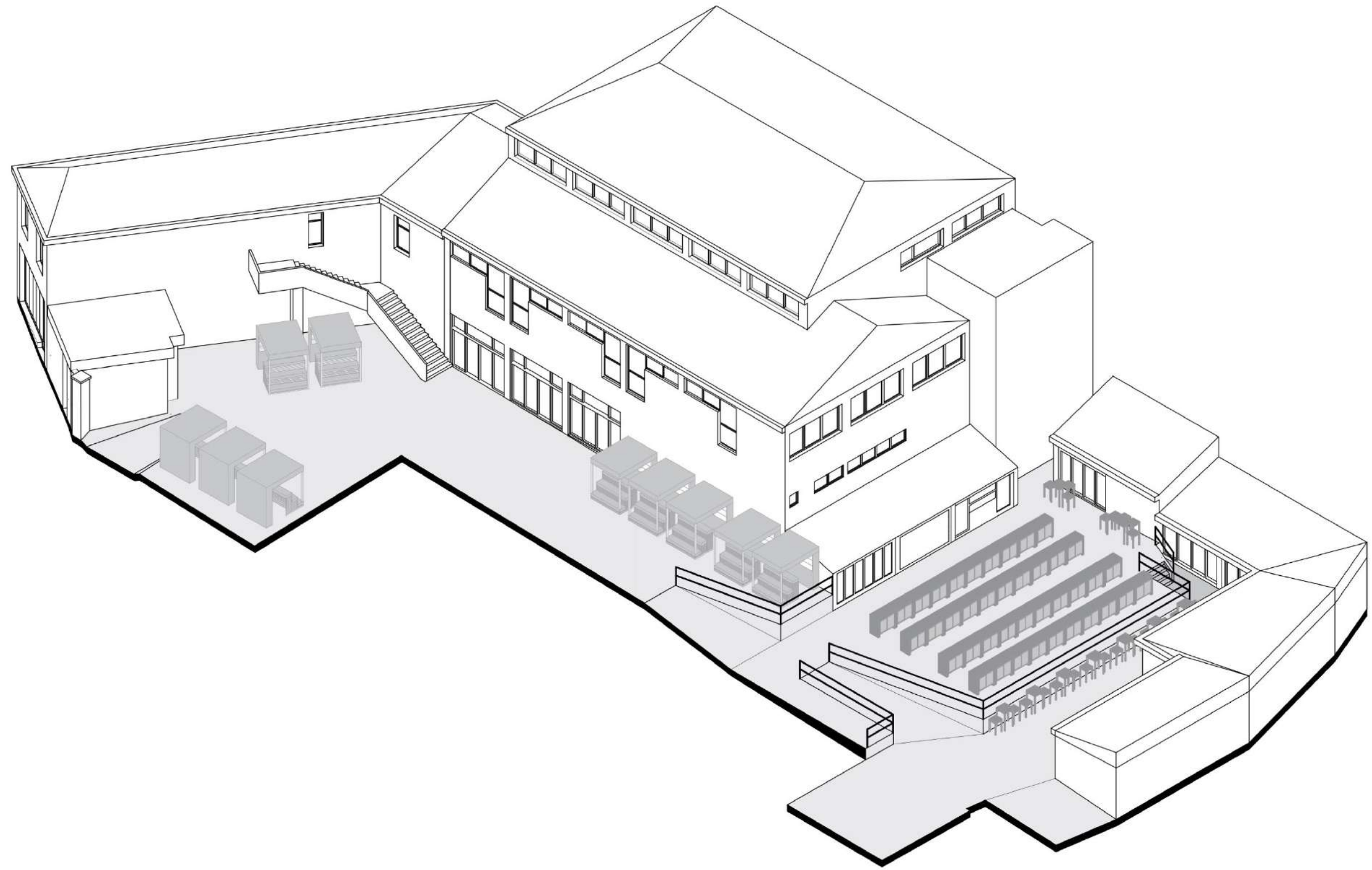

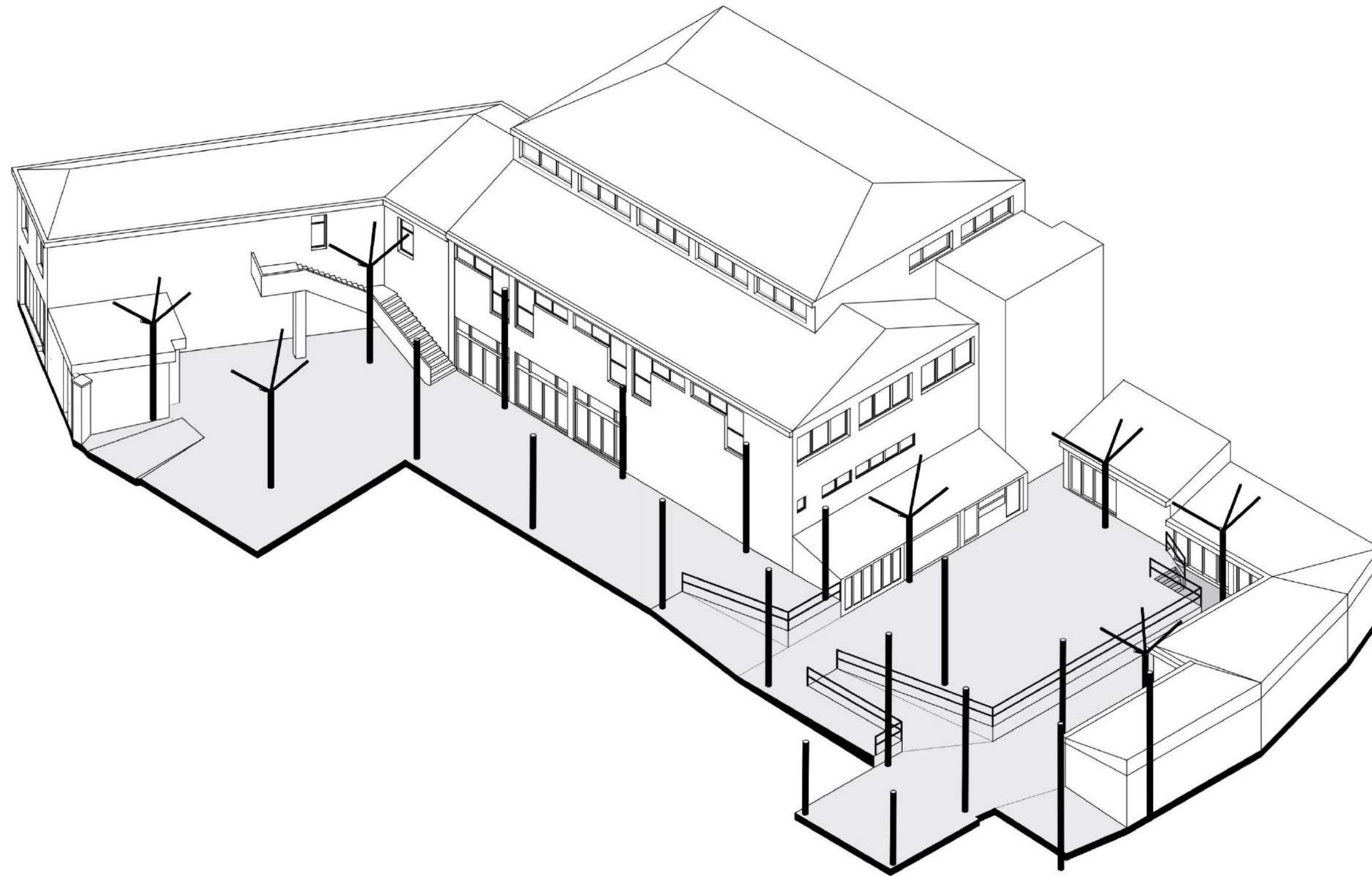

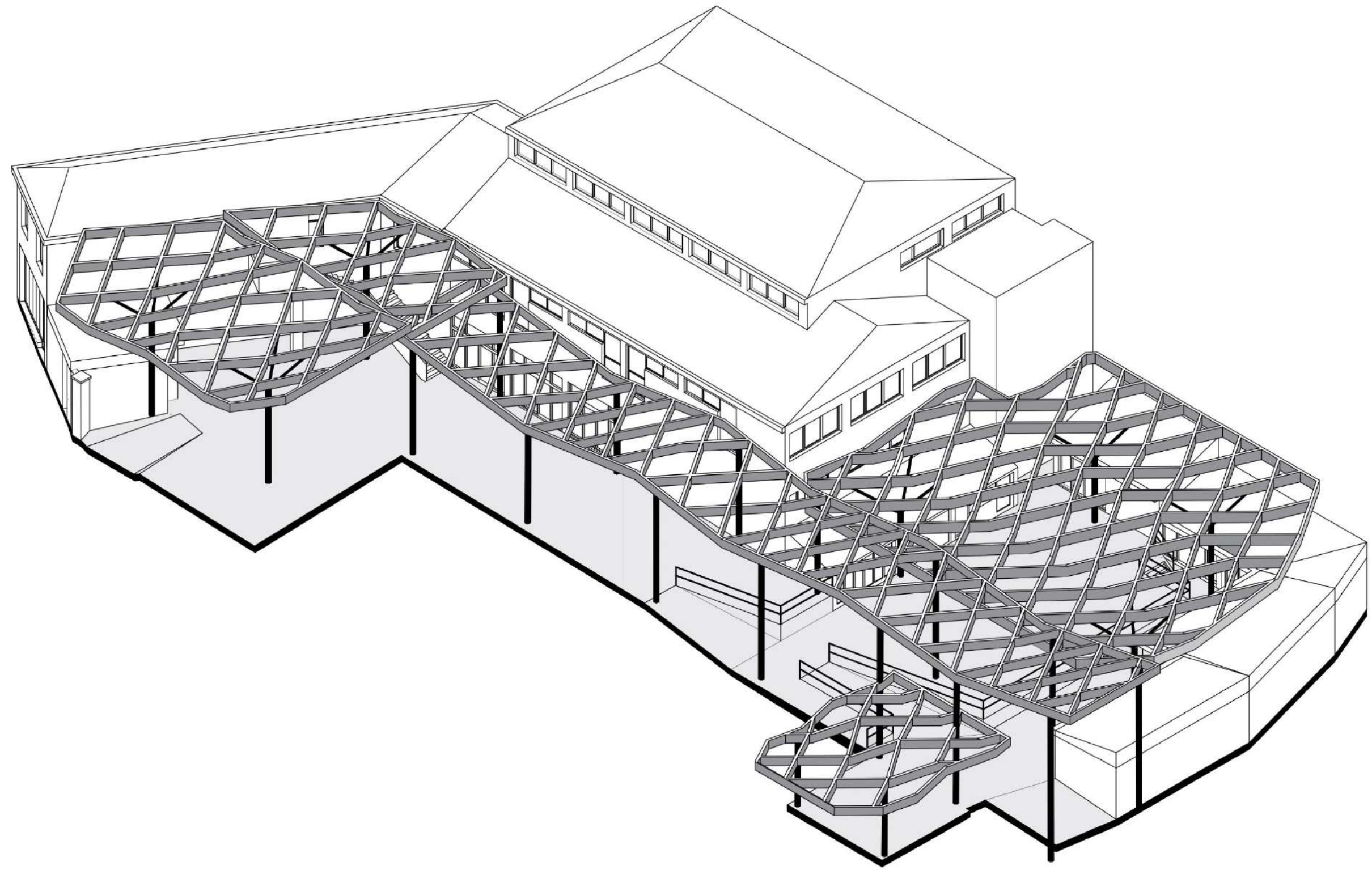

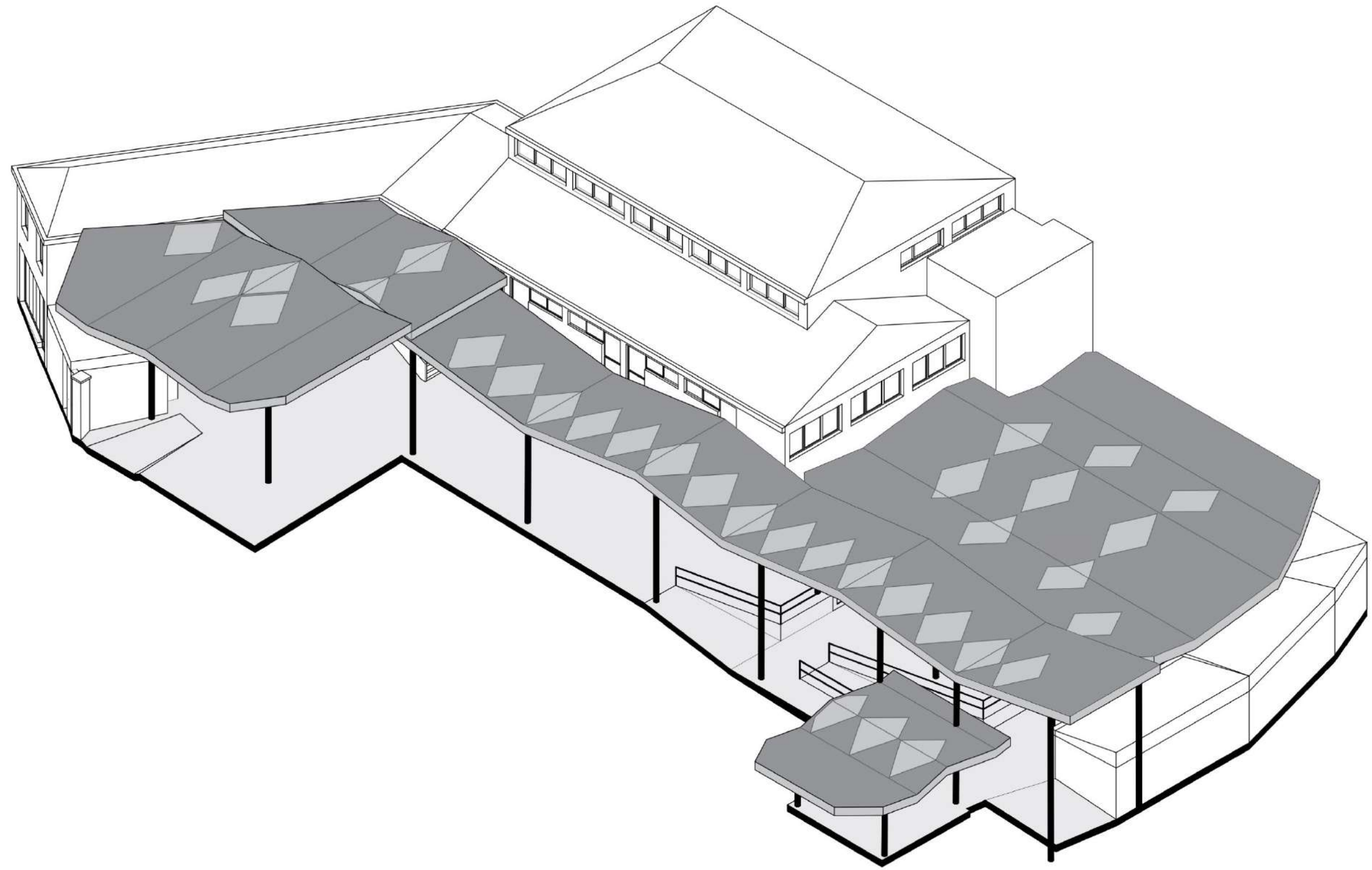

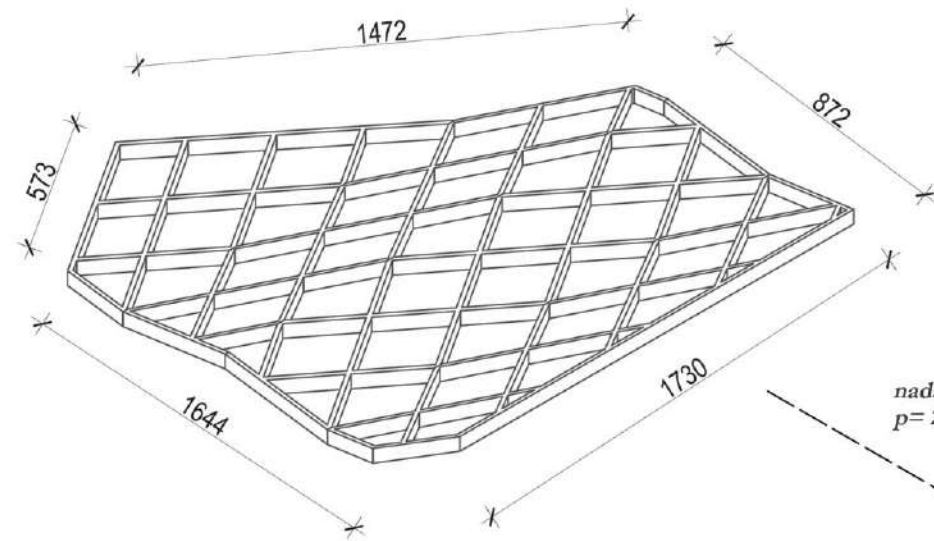

nadstrešnica D  
p= 226,70 m<sup>2</sup>

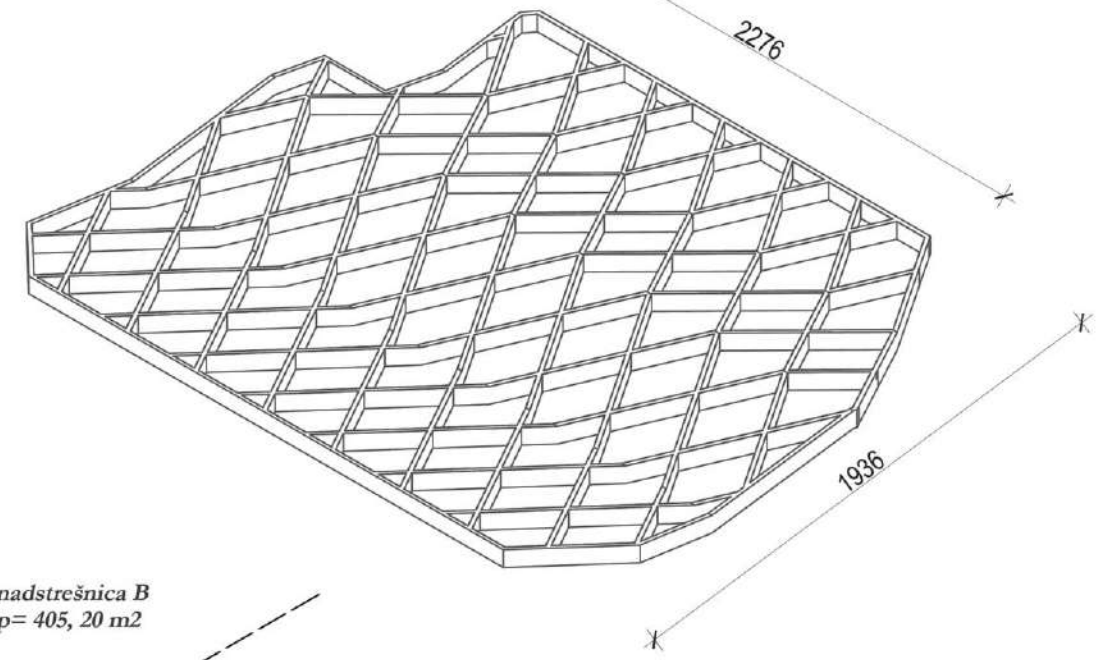

nadstrešnica B  
p= 405,20 m<sup>2</sup>

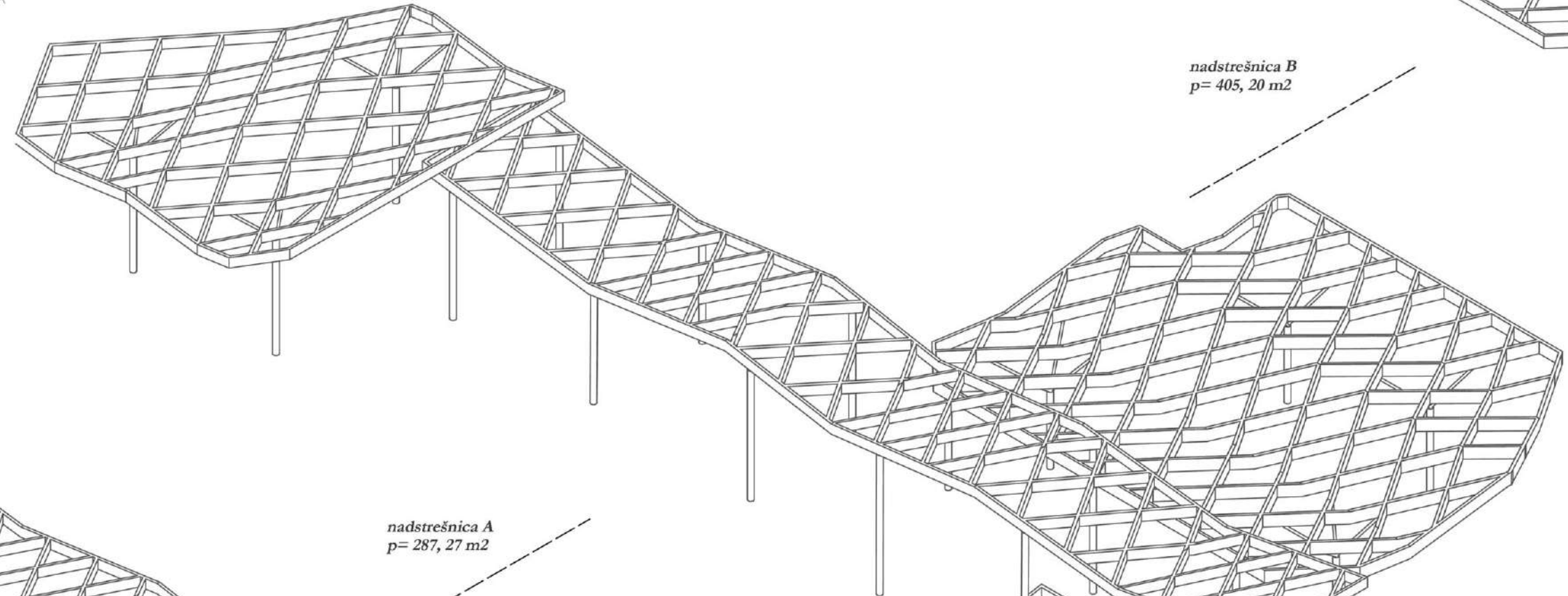

nadstrešnica A  
p= 287,27 m<sup>2</sup>

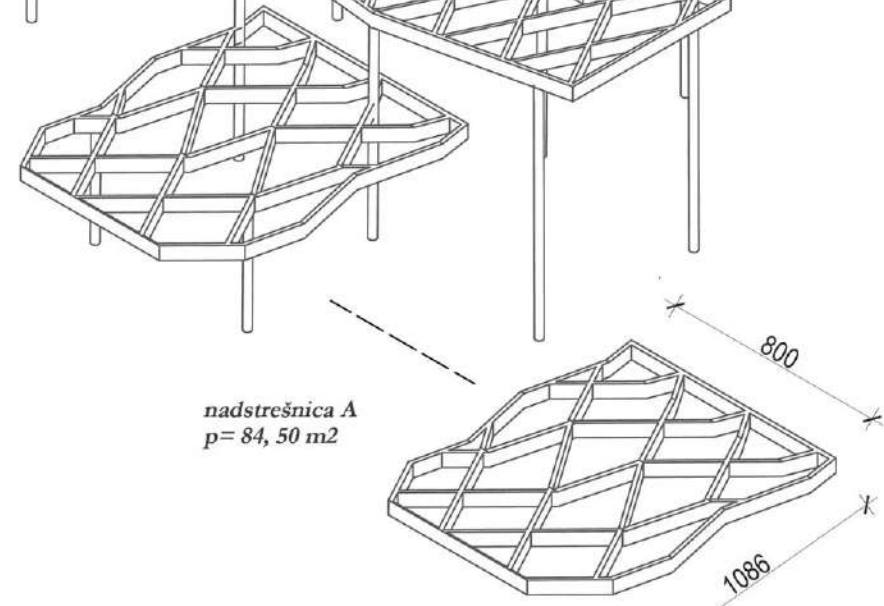
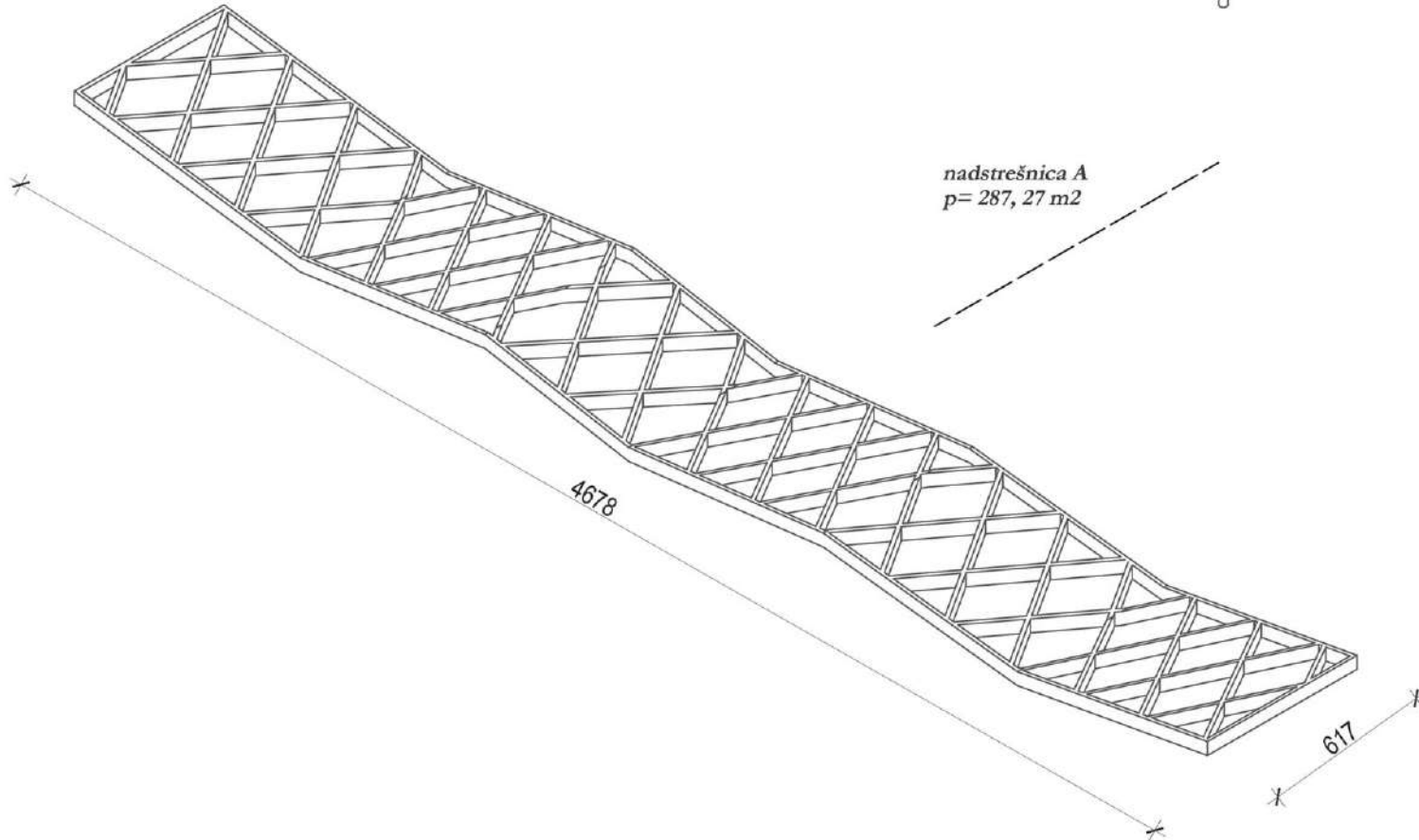

nadstrešnica A  
p= 84,50 m<sup>2</sup>

**PRESJEK A-A**



**PRESJEK B-B**



# PROČELJE A



# PROČELJE B

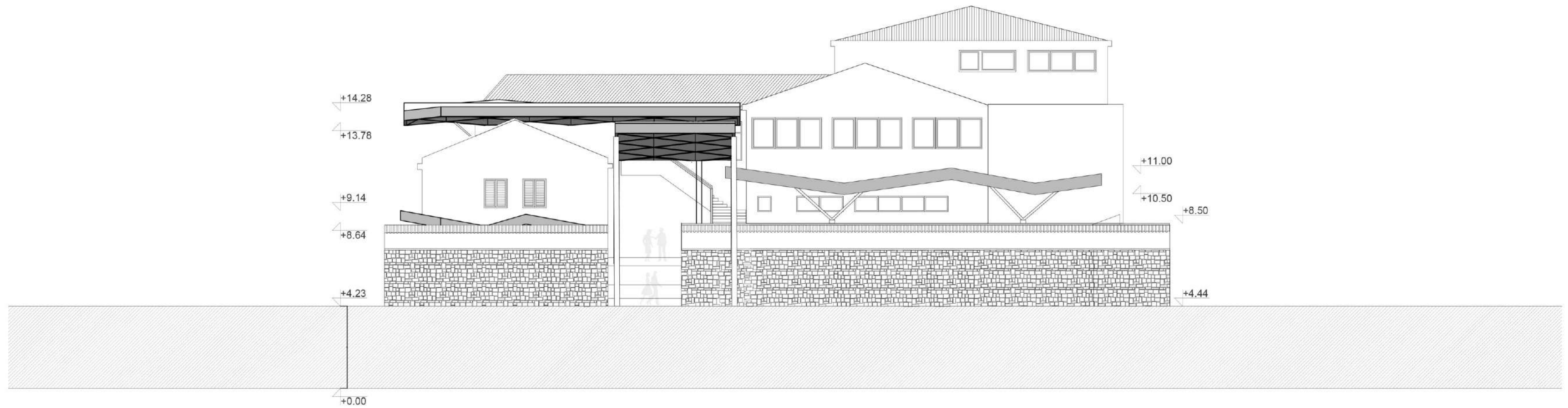





City  
← 30m

AGRARIA - ŽELJEZARIJA  
RITOŠA  
← 30m 052 452 589  
052 431 321  
HUNTING & FISHING

dm

P  
Bicycle symbol

dm  
0 - 24 h  
Tramvajni kolodnevnik  
max. 30 min



















